

Acct ID: 510603 MTL: 041W13C000800 Date: 3/12/24 Appr: CO Prop Class: 551 RMV Prop Class: 451
 Situs: 20608 HIGHWAY 99E NE AURORA OR 97002 MaSaNh: 02 06 000 Unit: 61590 Year: 2026

Last Date Appraised: 09/03/2014 Appraiser: JORDAN SCHULTZ Tag: Y D Tag info:

Owner: OREGON FLOWERS INC Last Sales Date: 09/23/2025 Roll Type: R

Cycle Tag Sales Verification Other: _____ Inspection level: 1 2 3 4 LCB TTO INSP AV: 308191

RMV Land: 304300 RMV Imp: 355320 RMV Total: 659620 MAV: 252480 MSAV: 57871 SAV: 77942

Comment: Eybs on structures remain. (NOT IN USE)
NOT LISTED ON OPEN MARKET CODE: 36

Notations

RP/MS	Code	Description
MS	ZONED	FARM EFU ZONED
RP	ZONED	FARM EFU ZONED

OSDs

Count	Code	Description	RMV	Code Area	Exception
2	SAA	SA OSD - AVERAGE	55000	15569	0

Land

Site: 2 Code Area: 15569 Size: 1.00 Acres Use Code: 005 Zone: UT SAV Use: 011 Exception: 0
 Class: 2BD Value Source: Farm Homesite Description: TWO BENCH DRY RMV: 20540 Exception: Y N
 Adjustment(s): GSOIL, IRR Fire Patrol: Description:
 Comments: Liability year - 2009 / 1500065

Site: 4 Code Area: 15569 Size: 1.00 Acres Use Code: 005 Zone: UT SAV Use: 011 Exception: 0
 Class: 2BD Value Source: Farm Homesite Description: TWO BENCH DRY RMV: 20540 Exception: Y N
 Adjustment(s): GSOIL, IRR Fire Patrol: Description:
 Comments: Liability year - 2009 / 1500065

Site: 5 Code Area: 15569 Size: 5.31 Acres Use Code: 005 Zone: UT SAV Use: 011 Exception: 0
 Class: 2BI Value Source: Farm Use - EFU Description: TWO BENCH IRR RMV: 114010 Exception: Y N
 Adjustment(s): GSOIL, IRR Fire Patrol: Description:
 Comments: Liability year - 1977 / 01500065

Site: 6 Code Area: 15569 Size: 2.00 Acres Use Code: 005 Zone: UT SAV Use: 011 Exception: 0
 Class: 4BI Value Source: Farm Use - EFU Description: FOUR BENCH IRR RMV: 39210 Exception: Y N
 Adjustment(s): GSOIL, IRR Fire Patrol: Description:
 Comments: Liability year - 1977

Improvements - Residence / Manufactured Structures

Bldg: 1 Code Area: 15569 Stat Class: 456 Year Blt: 1979 Eff Year Blt: 1979 Sq.Ft: 1440 % Complete: 100.00
 Desc: MANUF STRUCT, CLASS 5, 24' WIDE DOUBLE Dimensions: 60x24 RMV: 43630
 Func Obsc: 100 Econ %: 100 Other %: 100 Exception: 0 Adjust: Adjust RMV: 0 Subtype: R

Floors

Type	Class	Display Group	Floor Size	Beds	Baths	Yr Blt	Eff Yr Blt	Inventory	Exception
First Floor	5	Finished	1440	2	FB-2	1979	1979	SKIRT, ROOF+, HVAC+, KIT+, BATH - 2	Y N

Accessories

Description	Class	Size SqFt	Eff Yr Blt	RMV	Quantity	Exception
DECK	5	240	1979	1637	0	Y N

Bldg: 1 Code Area: 15569 Stat Class: 144 Year Blt: 1947 Eff Year Blt: 1938 Sq.Ft: 2258 % Complete: 100.00
 Desc: Multi Story above grade with basement Dimensions: RMV: 249190
 Func Obsc: 100 Econ %: 100 Other %: 100 Exception: 0 Adjust: Adjust RMV: 0

Floors

Type	Class	Display Group	Floor Size	Beds	Baths	Yr Blt	Eff Yr Blt	Inventory	Exception
First Floor	4	Finished	1189	0	FB-1	1947	1938	KIT-, ROOF, FP - 1, HVAC, BATH - 1	Y N
Attic	4	Finished	1069	3	FB-1	1947	1938	HVAC, BATH - 1	Y N
Basement	4	Unfinished	1165	0	0	1947	1938		Y N
Garage Attached	4	Unfinished	231	0	0	1947	1938	ROOF	Y N

Accessories

Description	Class	Size SqFt	Eff Yr Blt	RMV	Quantity	Exception
YARD IMPROVEMENTS FAIR	4	1	1938	9937	1	Y N

Bldg: 13 Code Area: 15569 Stat Class: 138 Year Blt: 1975 Eff Year Blt: 1975 Sq.Ft: 0 % Complete: 100.00
 Desc: Res other improvements Dimensions: RMV: 9570

Func Obsc: 100 Econ %: 100 Other %: 100 Exception: 0 Adjust: Adjust RMV: 0

Floors

Type	Class	Display Group	Floor Size	Beds	Baths	Yr Blt	Eff Yr Blt	Inventory	Exception: Y N
Carport Detached	3	Unfinished	324	0	0	1975	1975	ROOF	



Accessories

Description	Class	Size SqFt	Eff Yr Blt	RMV	Quantity
No accessory data available					

Improvements - Accessory Buildings

Bldg: 2 Code Area: 15569 Stat Class: 351 Year Blt: 1980 Eff Year Blt: 1980 Sq.Ft: 1500 % Complete: 100.00
 Desc: General Purpose Building (GB) Dimensions: 50x30 RMV: 7140
 Func Obsc: 100 Econ %: 100 Other %: 100 Exception: 0 Adjust: Adjust RMV: 0

Floors

Type	Class	Display Group	Floor Size	Beds	Baths	Yr Blt	Eff Yr Blt	Inventory	Exception: Y N
General Purpose Bldg	5	Finished	1500	0	0	1980	1980	FAIR	



Accessories

Description	Class	Size SqFt	Eff Yr Blt	RMV	Quantity
No accessory data available					

Bldg: 3 Code Area: 15569 Stat Class: 353 Year Blt: 1980 Eff Year Blt: 1980 Sq.Ft: 640 % Complete: 100.00
 Desc: Machine Shed (MS) Dimensions: 32x20 RMV: 2350
 Func Obsc: 100 Econ %: 100 Other %: 100 Exception: 0 Adjust: Adjust RMV: 0

Floors

Type	Class	Display Group	Floor Size	Beds	Baths	Yr Blt	Eff Yr Blt	Inventory	Exception: Y N
Machine Shed	5	Finished	640	0	0	1980	1980	FAIR	



Accessories

Description	Class	Size SqFt	Eff Yr Blt	RMV	Quantity
No accessory data available					

Bldg: 4 Code Area: 15569 Stat Class: 357 Year Blt: 1975 Eff Year Blt: 1975 Sq.Ft: 1500 % Complete: 100.00
 Desc: Frost Control Dimensions: 100x15 RMV: 960
 Func Obsc: 100 Econ %: 100 Other %: 100 Exception: 0 Adjust: Adjust RMV: 0

Floors

Type	Class	Display Group	Floor Size	Beds	Baths	Yr Blt	Eff Yr Blt	Inventory	Exception: Y N
Frost Control	4	Finished	1500	0	0	1975	1975		

Accessories

Description	Class	Size SqFt	Eff Yr Blt	RMV	Quantity
No accessory data available					

Bldg: 5 Code Area: 15569 Stat Class: 357 Year Blt: 1975 Eff Year Blt: 1975 Sq.Ft: 1920 % Complete: 100.00
 Desc: Frost Control Dimensions: 96x20 RMV: 1230
 Func Obsc: 100 Econ %: 100 Other %: 100 Exception: 0 Adjust: Adjust RMV: 0

Floors

Type	Class	Display Group	Floor Size	Beds	Baths	Yr Blt	Eff Yr Blt	Inventory	Exception: Y N
Frost Control	4	Finished	1920	0	0	1975	1975		

Accessories

Description	Class	Size SqFt	Eff Yr Blt	RMV	Quantity
No accessory data available					

Bldg: 6 Code Area: 15569 Stat Class: 357 Year Blt: 1975 Eff Year Blt: 1975 Sq.Ft: 1344 % Complete: 100.00
 Desc: Frost Control Dimensions: 96x14 RMV: 860
 Func Obsc: 100 Econ %: 100 Other %: 100 Exception: 0 Adjust: Adjust RMV: 0

Floors

Type	Class	Display Group	Floor Size	Beds	Baths	Yr Blt	Eff Yr Blt	Inventory	Exception: Y N
Frost Control	4	Finished	1344	0	0	1975	1975		

Accessories

Description	Class	Size SqFt	Eff Yr Blt	RMV	Quantity
No accessory data available					

Bldg: 7 Code Area: 15569 Stat Class: 332 Year Blt: 1975 Eff Year Blt: 1975 Sq.Ft: 7840 % Complete: 100.00
 Desc: Commercial Greenhouse (CG) Dimensions: 98x80 RMV: 10070

Func Obsc: 100 Econ %: 100 Other %: 100 Exception: 0 Adjust: Adjust RMV: 0

Floors

Type	Class	Display Group	Floor Size	Beds	Baths	Yr Blt	Eff Yr Blt	Inventory
Commerical Greenhouse	5	Finished	7840	0	0	1975	1975	Exception: Y N

Accessories

Description	Class	Size SqFt	Eff Yr Blt	RMV	Quantity
No accessory data available					

Bldg: 8 Code Area: 15569 Stat Class: 355 Year Blt: 1975 Eff Year Blt: 1975 Sq.Ft: 1800 % Complete: 100.00
 Desc: Lean-to Heavy (LTH) Dimensions: 60x30 RMV: 2680
 Func Obsc: 100 Econ %: 100 Other %: 100 Exception: 0 Adjust: Adjust RMV: 0

Floors

Type	Class	Display Group	Floor Size	Beds	Baths	Yr Blt	Eff Yr Blt	Inventory
Lean-to Heavy Duty	4	Finished	1800	0	0	1975	1975	Exception: Y N

Accessories

Description	Class	Size SqFt	Eff Yr Blt	RMV	Quantity
No accessory data available					

Bldg: 9 Code Area: 15569 Stat Class: 351 Year Blt: 1980 Eff Year Blt: 1980 Sq.Ft: 600 % Complete: 100.00
 Desc: General Purpose Building (GB) Dimensions: 30x20 RMV: 3050
 Func Obsc: 100 Econ %: 100 Other %: 100 Exception: 0 Adjust: Adjust RMV: 0

Floors

Type	Class	Display Group	Floor Size	Beds	Baths	Yr Blt	Eff Yr Blt	Inventory
General Purpose Bldg	5	Finished	600	0	0	1980	1980	FAIR Exception: Y N

Accessories

Description	Class	Size SqFt	Eff Yr Blt	RMV	Quantity
No accessory data available					

Bldg: 10 Code Area: 15569 Stat Class: 332 Year Blt: 1980 Eff Year Blt: 1980 Sq.Ft: 6400 % Complete: 100.00
 Desc: Commercial Greenhouse (CG) Dimensions: 80x80 RMV: 8220
 Func Obsc: 100 Econ %: 100 Other %: 100 Exception: 0 Adjust: Adjust RMV: 0

Floors

Type	Class	Display Group	Floor Size	Beds	Baths	Yr Blt	Eff Yr Blt	Inventory
Commerical Greenhouse	5	Finished	6400	0	0	1980	1980	Exception: Y N

Accessories

Description	Class	Size SqFt	Eff Yr Blt	RMV	Quantity
No accessory data available					

Bldg: 11 Code Area: 15569 Stat Class: 332 Year Blt: 1980 Eff Year Blt: 1980 Sq.Ft: 1080 % Complete: 100.00
 Desc: Commercial Greenhouse (CG) Dimensions: 40x27 RMV: 770
 Func Obsc: 100 Econ %: 100 Other %: 100 Exception: 0 Adjust: Adjust RMV: 0

Floors

Type	Class	Display Group	Floor Size	Beds	Baths	Yr Blt	Eff Yr Blt	Inventory
Commerical Greenhouse	4	Finished	1080	0	0	1980	1980	Exception: Y N

Accessories

Description	Class	Size SqFt	Eff Yr Blt	RMV	Quantity
No accessory data available					

Bldg: 12 Code Area: 15569 Stat Class: 357 Year Blt: 1975 Eff Year Blt: 1975 Sq.Ft: 1920 % Complete: 100.00
 Desc: Frost Control Dimensions: 96x20 RMV: 1230
 Func Obsc: 100 Econ %: 100 Other %: 100 Exception: 0 Adjust: Adjust RMV: 0

Floors

Type	Class	Display Group	Floor Size	Beds	Baths	Yr Blt	Eff Yr Blt	Inventory
Frost Control	4	Finished	1920	0	0	1975	1975	Exception: Y N

Accessories

Description	Class	Size SqFt	Eff Yr Blt	RMV	Quantity
No accessory data available					

Bldg: 14 Code Area: 15569 Stat Class: 357 Year Blt: 1975 Eff Year Blt: 1975 Sq.Ft: 1500 % Complete: 100.00
 Desc: Frost Control Dimensions: 50x30 RMV: 960
 Func Obsc: 100 Econ %: 100 Other %: 100 Exception: 0 Adjust: Adjust RMV: 0

Floors

Type	Class	Display Group	Floor Size	Beds	Baths	Yr Blt	Eff Yr Blt	Inventory
Frost Control	4	Finished	1500	0	0	1975	1975	Exception: Y N

Accessories

Description	Class	Size SqFt	Eff Yr Blt	RMV	Quantity
No accessory data available					

Bldg: 15 Code Area: 15569 Stat Class: 357 Year Blt: Eff Year Blt: 1975 Sq.Ft: 1500 % Complete: 100.00
 Desc: Frost Control Dimensions: RMV: 960
 Func Obsc: 100 Econ %: 100 Other %: 100 Exception: 0 Adjust: Adjust RMV: 0

Floors

Type	Class	Display Group	Floor Size	Beds	Baths	Yr Blt	Eff Yr Blt	Inventory
Frost Control	4	Finished	1500	0	0	1975	1975	Exception: Y N

Accessories

Description	Class	Size SqFt	Eff Yr Blt	RMV	Quantity
No accessory data available					

Bldg: 16 Code Area: 15569 Stat Class: 357 Year Blt: Eff Year Blt: 1975 Sq.Ft: 1500 % Complete: 100.00
 Desc: Frost Control Dimensions: RMV: 960
 Func Obsc: 100 Econ %: 100 Other %: 100 Exception: 0 Adjust: Adjust RMV: 0

Floors

Type	Class	Display Group	Floor Size	Beds	Baths	Yr Blt	Eff Yr Blt	Inventory
Frost Control	4	Finished	1500	0	0	1975	1975	Exception: Y N

Accessories

Description	Class	Size SqFt	Eff Yr Blt	RMV	Quantity
No accessory data available					

Bldg: 17 Code Area: 15569 Stat Class: 357 Year Blt: Eff Year Blt: 1975 Sq.Ft: 1500 % Complete: 100.00
 Desc: Frost Control Dimensions: RMV: 960
 Func Obsc: 100 Econ %: 100 Other %: 100 Exception: 0 Adjust: Adjust RMV: 0

Floors

Type	Class	Display Group	Floor Size	Beds	Baths	Yr Blt	Eff Yr Blt	Inventory
Frost Control	4	Finished	1500	0	0	1975	1975	Exception: Y N

Accessories

Description	Class	Size SqFt	Eff Yr Blt	RMV	Quantity
No accessory data available					

Bldg: 18 Code Area: 15569 Stat Class: 357 Year Blt: Eff Year Blt: 1975 Sq.Ft: 1500 % Complete: 100.00
 Desc: Frost Control Dimensions: RMV: 960
 Func Obsc: 100 Econ %: 100 Other %: 100 Exception: 0 Adjust: Adjust RMV: 0

Floors

Type	Class	Display Group	Floor Size	Beds	Baths	Yr Blt	Eff Yr Blt	Inventory
Frost Control	4	Finished	1500	0	0	1975	1975	Exception: Y N

Accessories

Description	Class	Size SqFt	Eff Yr Blt	RMV	Quantity
No accessory data available					

Bldg: 19 Code Area: 15569 Stat Class: 357 Year Blt: Eff Year Blt: 1975 Sq.Ft: 1500 % Complete: 100.00
 Desc: Frost Control Dimensions: RMV: 960
 Func Obsc: 100 Econ %: 100 Other %: 100 Exception: 0 Adjust: Adjust RMV: 0

Floors

Type	Class	Display Group	Floor Size	Beds	Baths	Yr Blt	Eff Yr Blt	Inventory
Frost Control	4	Finished	1500	0	0	1975	1975	Exception: Y N

Accessories

Description	Class	Size SqFt	Eff Yr Blt	RMV	Quantity
No accessory data available					

Bldg: 20 Code Area: 15569 Stat Class: 357 Year Blt: Eff Year Blt: 1975 Sq.Ft: 1920 % Complete: 100.00
 Desc: Frost Control Dimensions: RMV: 1230
 Func Obsc: 100 Econ %: 100 Other %: 100 Exception: 0 Adjust: Adjust RMV: 0

Floors

Type	Class	Display Group	Floor Size	Beds	Baths	Yr Blt	Eff Yr Blt	Inventory
Frost Control	4	Finished	1920	0	0	1975	1975	Exception: Y N

Accessories

Description	Class	Size SqFt	Eff Yr Blt	RMV	Quantity
No accessory data available					

Bldg: 21 Code Area: 15569 Stat Class: 357 Year Blt: Eff Year Blt: 1975 Sq.Ft: 1920 % Complete: 100.00
 Desc: Frost Control Dimensions: RMV: 1230
 Func Obsc: 100 Econ %: 100 Other %: 100 Exception: 0 Adjust: Adjust RMV: 0

Floors

Type	Class	Display Group	Floor Size	Beds	Baths	Yr Blt	Eff Yr Blt	Inventory
Frost Control	4	Finished	1920	0	0	1975	1975	Exception: Y N

Accessories

Description	Class	Size SqFt	Eff Yr Blt	RMV	Quantity
No accessory data available					

Bldg: 22 Code Area: 15569 Stat Class: 357 Year Blt: Eff Year Blt: 1975 Sq.Ft: 1920 % Complete: 100.00
 Desc: Frost Control Dimensions: RMV: 1230
 Func Obsc: 100 Econ %: 100 Other %: 100 Exception: 0 Adjust: Adjust RMV: 0

Floors

Type	Class	Display Group	Floor Size	Beds	Baths	Yr Blt	Eff Yr Blt	Inventory
Frost Control	4	Finished	1920	0	0	1975	1975	Exception: Y N

Accessories

Description	Class	Size SqFt	Eff Yr Blt	RMV	Quantity
No accessory data available					

Bldg: 23 Code Area: 15569 Stat Class: 357 Year Blt: Eff Year Blt: 1975 Sq.Ft: 1920 % Complete: 100.00
 Desc: Frost Control Dimensions: RMV: 1230
 Func Obsc: 100 Econ %: 100 Other %: 100 Exception: 0 Adjust: Adjust RMV: 0

Floors

Type	Class	Display Group	Floor Size	Beds	Baths	Yr Blt	Eff Yr Blt	Inventory
Frost Control	4	Finished	1920	0	0	1975	1975	Exception: Y N

Accessories

Description	Class	Size SqFt	Eff Yr Blt	RMV	Quantity
No accessory data available					

Bldg: 24 Code Area: 15569 Stat Class: 357 Year Blt: Eff Year Blt: 1975 Sq.Ft: 1920 % Complete: 100.00
 Desc: Frost Control Dimensions: RMV: 1230
 Func Obsc: 100 Econ %: 100 Other %: 100 Exception: 0 Adjust: Adjust RMV: 0

Floors

Type	Class	Display Group	Floor Size	Beds	Baths	Yr Blt	Eff Yr Blt	Inventory
Frost Control	4	Finished	1920	0	0	1975	1975	Exception: Y N

Accessories

Description	Class	Size SqFt	Eff Yr Blt	RMV	Quantity
No accessory data available					

Bldg: 25 Code Area: 15569 Stat Class: 357 Year Blt: Eff Year Blt: 1975 Sq.Ft: 1920 % Complete: 100.00
 Desc: Frost Control Dimensions: RMV: 1230
 Func Obsc: 100 Econ %: 100 Other %: 100 Exception: 0 Adjust: Adjust RMV: 0

Floors

Type	Class	Display Group	Floor Size	Beds	Baths	Yr Blt	Eff Yr Blt	Inventory
Frost Control	4	Finished	1920	0	0	1975	1975	Exception: Y N

Accessories

Description	Class	Size SqFt	Eff Yr Blt	RMV	Quantity
No accessory data available					

Bldg: 26 Code Area: 15569 Stat Class: 357 Year Blt: Eff Year Blt: 1975 Sq.Ft: 1920 % Complete: 100.00
 Desc: Frost Control Dimensions: RMV: 1230
 Func Obsc: 100 Econ %: 100 Other %: 100 Exception: 0 Adjust: Adjust RMV: 0

Floors

Type	Class	Display Group	Floor Size	Beds	Baths	Yr Blt	Eff Yr Blt	Inventory
Frost Control	4	Finished	1920	0	0	1975	1975	Exception: Y N

Accessories

Description	Class	Size SqFt	Eff Yr Blt	RMV	Quantity
No accessory data available					

SKETCH/AREA TABLE ADDENDUM

Parcel No 041W13C 00800

File No R10603

Property Address 20608-20668 HIGHWAY 99E NE

City AURORA

State OR

Zip 97002

Owner

Client

Appraiser Name

SUBJECT

IMPROVEMENTS SKETCH

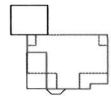
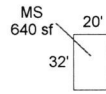
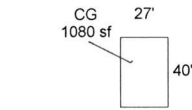
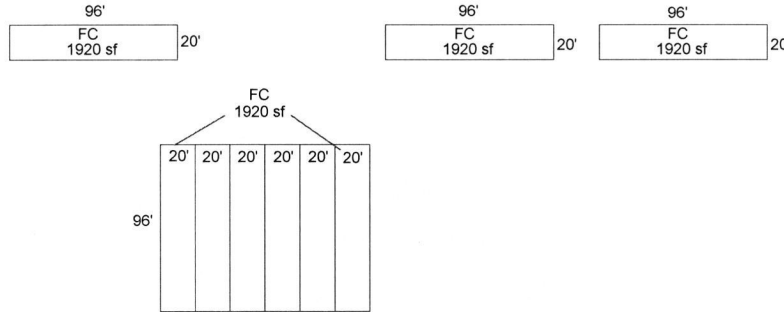

FC 1500 sf

See Page 2 For Res Dimensions

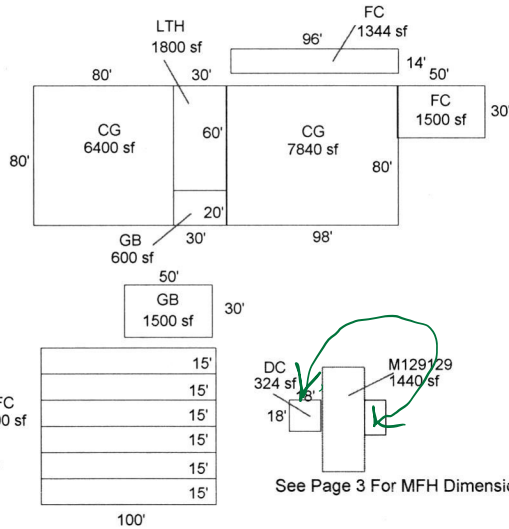

Scale: 1 = 110

AREA CALCULATIONS

AREA CALCULATIONS SUMMARY

Code	Description	Factor	Net Size	Perimeter	Net Totals
GLA1	MA	1.00	1189	156	1189
GLA2	ATTF	1.00	1069	154	1069
GBA1	FC	1.00	1920	232	
	FC	1.00	1920	232	
	FC	1.00	1920	232	
	FC	1.00	1920	232	
	FC	1.00	1920	232	
	FC	1.00	1920	232	
	FC	1.00	1920	232	
	FC	1.00	1920	232	
	FC	1.00	1920	232	
	CG	1.00	1080	134	
	CG	1.00	6400	320	
	LTH	1.00	1800	180	
	CG	1.00	7840	356	
	FC	1.00	1344	220	
	GB	1.00	600	100	
	GB	1.00	1500	160	
	FC	1.00	1500	230	
	FC	1.00	1500	230	
----- 11 Items Not Listed -----					
Net LIVABLE Area (rounded w/ factors)					2258
Net BUILDING Area (rounded w/ factors)					48984

Comment Table 1

APEX BY CE 3/19/10

Comment Table 2

Comment Table 3

SKETCH/AREA TABLE ADDENDUM

Parcel No 041W13C 00800

File No R10603

SUBJECT

Property Address 20608-20668 HIGHWAY 99E NE

City AURORA

State OR

Zip 97002

Owner

Client

Appraiser Name

IMPROVEMENTS SKETCH

R10603
041W13C 00800



See Page 1 for All Bldgs

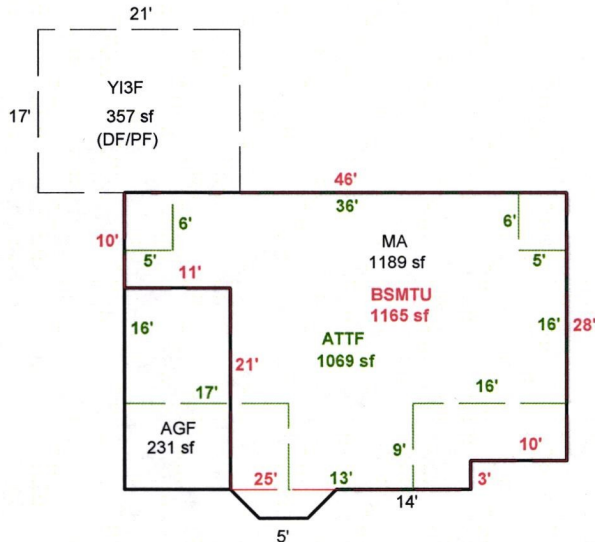

Scale: 1 = 20

AREA CALCULATIONS

AREA CALCULATIONS SUMMARY

Code	Description	Factor	Net Size	Perimeter	Net Totals
GLA1	MA	1.00	1189	156	1189
GLA2	ATTF	1.00	1069	154	1069
BSMT	BSMTU	1.00	1165	154	1165
GARAGE	AGF	1.00	231	64	231
Net LIVABLE Area (rounded w/ factors)					2258

Comment Table 1

APEX BY CE 3/19/10

Comment Table 2

Comment Table 3

SKETCH/AREA TABLE ADDENDUM

Parcel No 041W13C 00800

File No R10603

Property Address 20608-20668 HIGHWAY 99E NE

City AURORA

State OR

Zip 97002

Owner

Client

Appraiser Name

SUBJECT

IMPROVEMENTS SKETCH

R10603
041W13C 00800

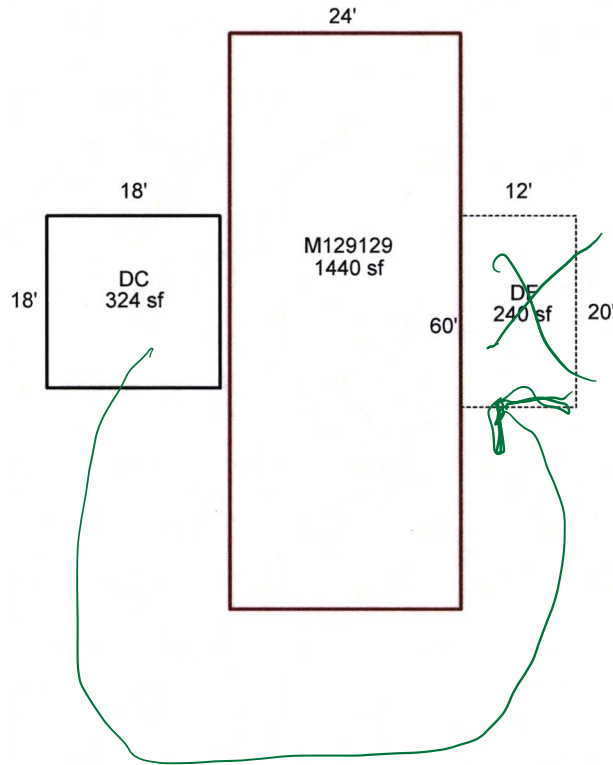

Scale: 1 = 20

AREA CALCULATIONS

AREA CALCULATIONS SUMMARY

Code	Description	Factor	Net Size	Perimeter	Net Totals
GARAGE	DC	1.00	324	72	324
P/P	DF	1.00	240	64	240
OTH	M129129	1.00	1440	168	1440

Comment Table 1

APEX BY CE 3/19/10

Comment Table 2

Comment Table 3